

# Pareti divisorie per servizi igienici SVF30

Pannelli in truciolare di qualità, spess. 30 mm

**schäfer**<sup>®</sup>  
Trennwandsysteme



So schön kann Trennung sein.



PRIMA DI  
PRETENDERE LA FIDUCIA  
DEI NOSTRI CLIENTI,  
DIMOSTRIAMO IL  
NOSTRO VALORE  
*tipico di Schäfer.*

### SICUREZZA CERTIFICATA DA TÜV NORD GS *tipico di Schäfer.*

Testati e certificati da TÜV NORD, questi prodotti sono conformi ai requisiti della legge sulla sicurezza dei prodotti ProdSG § 21 n. registrazione 44 329 14148802.



### MADE IN GERMANY *tipico di Schäfer.*

I nostri prodotti sono realizzati nella sede aziendale di Horhausen, nella Renania-Palatinato. Solo così possiamo garantire anche i più elevati requisiti di qualità che ci poniamo per i nostri prodotti.



### INNOVAZIONE E ORIENTAMENTO AL DESIGN *tipico di Schäfer.*

Con i nostri prodotti innovativi e orientati al design stupiamo non solo i nostri clienti, bensì anche gruppi di esperti nazionali e internazionali.



### PREQUALIFICATE *tipico di Schäfer.*

Siamo nell'elenco delle aziende produttrici prequalificate con il numero 010.049740 a chiara indicazione che siamo qualificati per i prodotti e i servizi che offriamo.





## Elegante, economico con un design collaudato.

Il modello Schäfer modello SVF30, per chi desidera avere una cabina economica, funzionale con un design ricercato. Le cabine con pannelli di truciolato rivestiti di resina melamminica e bordi chiusi con un profilo ABS garantiscono una lunga durata negli ambienti asciutti. Con questo prodotto avete tutto in uno: elegante, funzionale, economico e facile da pulire. Questi sono argomenti vincenti per questo tipo di divisori.



#### Caratteristiche del modello SVF30

##### Elementi prefabbricati composti da pannelli in truciolare di qualità, spess. 30 mm

- Superficie melamminica colorata fornibile in diversi colori standard
- Tutti i bordi e spigoli a vista chiusi con profili colorati in ABS
- Superficie a filo parete
- Ideali per ambienti asciutti

##### Pareti divisorie per orinatoi modello SV30

- Fissati a parete
- Pannello truciolare, spess. 30 mm superficie rivestita con resina melamminica
- Bordo perimetrale con profilo ABS in colori a scelta
- Fissaggio mediante staffe/rosette in alluminio anodizzato
- Vasta scelta di colori disponibili





## Dettagli modello SVF30

### Piedini:



- Piedino regolabile in acciaio inox con rosetta di copertura



- Piedino regolabile in alluminio anodizzato con rosetta di copertura

### Cerniere:



- Cerniera in acciaio inox con apertura max. 180° senza chiusura automatica



- Cerniera in acciaio inox con boccole in nylon per chiusura automatica



- Cerniera in alluminio
- Superfici di scorrimento in polimero ad alte prestazioni
- A scelta con o senza funzione di chiusura automatica
- Disponibile come opzione

## Accessori per il modello SVF30

### Pomoli e maniglie:



Coppia maniglia  
in alluminio  
Schäfer AL7050



Coppia maniglia  
in acciaio inox  
Schäfer ES6050



Coppia maniglia  
in nylon\*  
Schäfer N8051



Pomolo in alluminio  
tipo INSAFE



Maniglia SLIDESAFE  
in alluminio

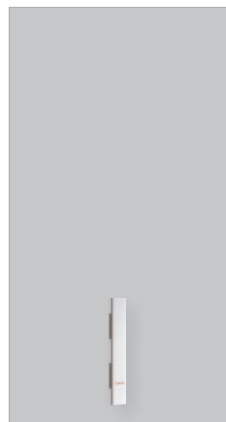

Maniglia a barra  
in alluminio  
55 x 500 mm  
Schäfer ALGS1

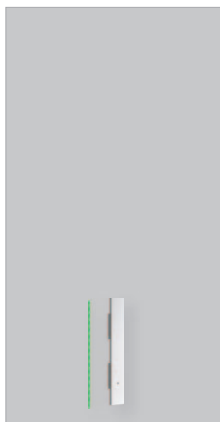

Maniglia a barra in  
alluminio con striscia LED  
55 x 500 mm  
Schäfer ALGS1 LED



Maniglia a barra  
in alluminio  
55 x 1.150 mm  
Schäfer ALGS2

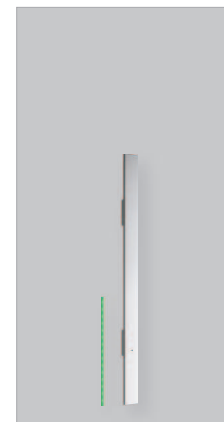

Maniglia a barra in  
alluminio con striscia LED  
55 x 1.150 mm  
Schäfer ALGS2 LED

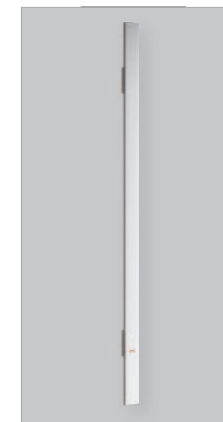

Maniglia a barra  
in alluminio, adatto  
all'altezza della porta  
Schäfer ALGSV

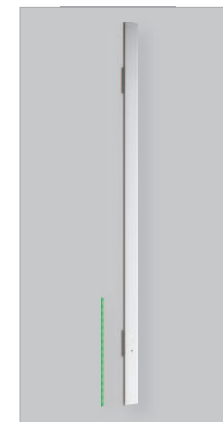

Maniglia a barra in  
alluminio con striscia LED,  
adatto all'altezza della porta  
Schäfer ALGSV LED

### Puffer e appendiabiti:



Puffer per porte  
in alluminio  
Schäfer AL7015



Puffer per porte  
in acciaio inox  
Schäfer ES6015



Puffer per porte  
in nylon\*  
Schäfer N8015



Appendiabiti  
in alluminio  
Schäfer AL7011



Appendiabiti  
in acciaio inox  
Schäfer ES6011



Appendiabiti  
in nylon\*  
Schäfer N8010

\* Tutte le finiture in nylon  
sono disponibili  
in RAL 9010 e RAL 7038

## Varianti di allestimento opzionale tipo SVF30 BLACKLINE

I raccordi della serie BLACKLINE possono essere scelti come opzione per il tipo SVF30.



BLACKLINE  
Pomolo in alluminio tipo INSAFE  
con indicatore di libero/occupato  
ben visibile



BLACKLINE  
Coppia maniglia in acciaio inox  
con catenaccio, indicatore di libero/occupato  
e fessura di apertura di emergenza  
all'esterno della cabina

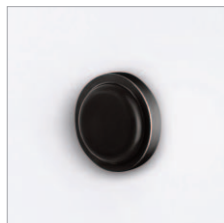

BLACKLINE  
Paracolpi in alluminio,  
fissaggio invisibile  
Schäfer AL7015S



BLACKLINE  
Gancio in alluminio  
Schäfer AL7011S



BLACKLINE  
Cerniera in alluminio  
con funzione di chiusura automatica



**BLACKLINE**



## Cartella colori per il modello SVF30

### Pannelli e porte:



1001  
Bianco

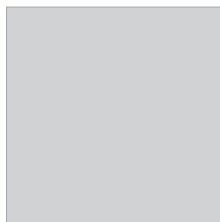

1002  
Grigio argento



1004  
Antracite



1005  
Rosso



1006  
Verde limone



1007  
Blu acqua

### Bordi ABS:



1001  
Bianco

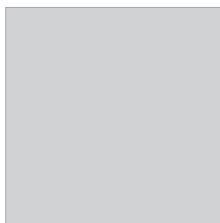

1002  
Grigio argento



1004  
Antracite



1005  
Rosso



6001  
Giallo oro



1006  
Verde limone



1007  
Blu acqua



6002  
Blu oltremare

### Profili e fissaggi:

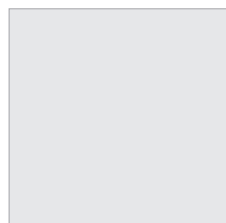

E6/EV1  
Alluminio anodizzato

Per il modello SVF30S sono disponibili i colori bianco (3001), antracite (3004) e nero (3009).

I colori speciali per le decorazioni dei pannelli e i bordi ABS, nonché in tutti i colori RAL e i complementi speciali sono disponibili sulla base dei vostri desideri.

Sono possibili variazioni di colore rispetto all'originale.

Dettagli tecnici modello SVF30

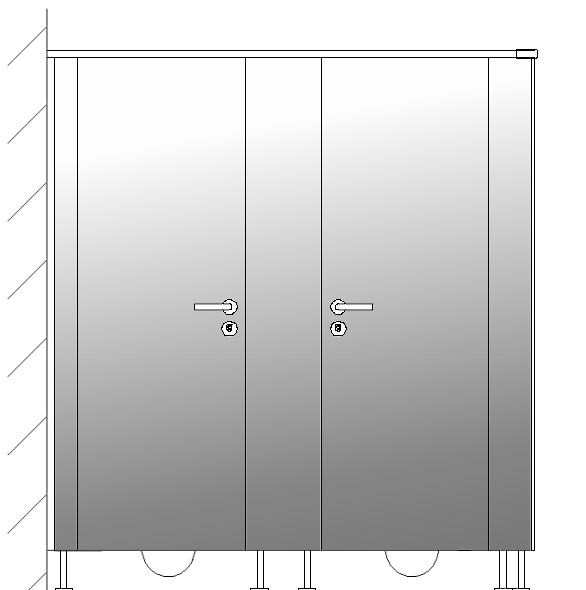
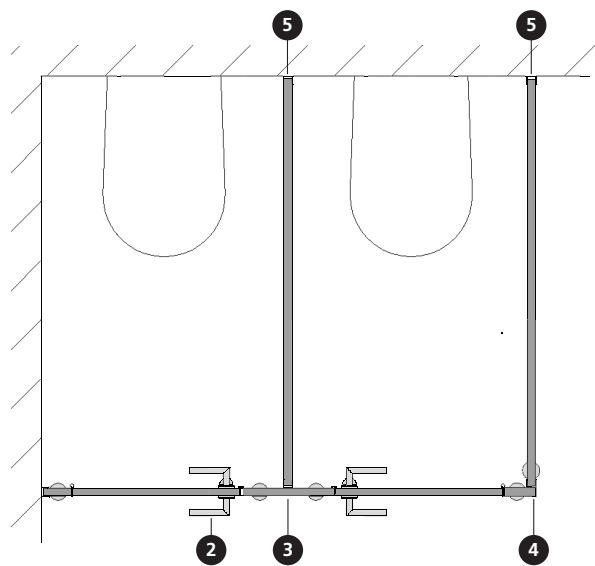

2 Vista planimetrica frontale con porta con cerniera 180°

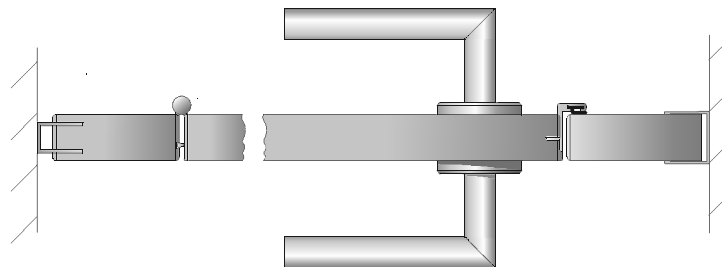

Sezione verticale

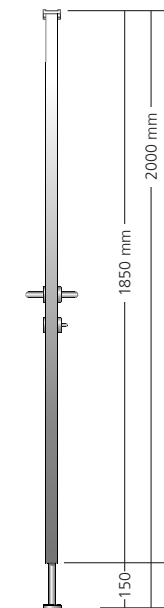

4 Raccordo angolare

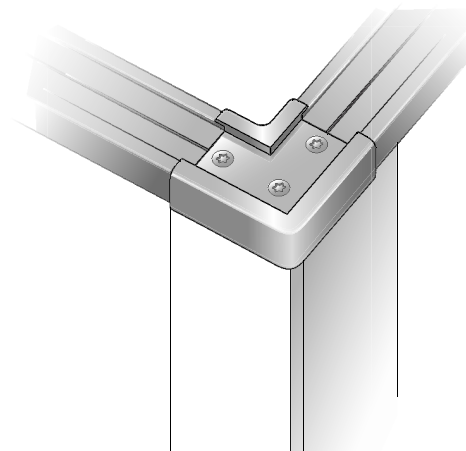

3 Fissaggio interno parete (parete divisoria - parete frontale)

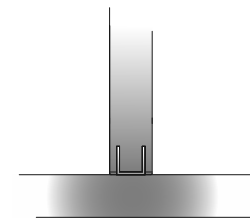

5 Fissaggio a parete con profilo a U

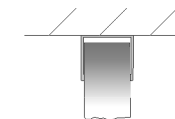

5 Fissaggio a parete con profilo interno a parete

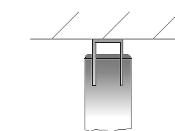

Modifiche tecniche riservate.

Schäfer Trennwandsysteme GmbH  
Industriepark 37  
D-56593 Horhausen  
Tel.: +49 (0)2687/9151-0  
info@schaefer-tws.de  
[www.schaefer-tws.de](http://www.schaefer-tws.de)

Schäfer Trennwandsysteme GmbH  
**Ufficio Italia**  
Via Feldgatter 2/3  
I-39011 Lana (BZ)  
Tel.: +39 0473 / 864760  
info@schaefer-tws.it  
[www.schaefer-tws.it](http://www.schaefer-tws.it)

