

Pareti divisorie per servizi igienici SVF30

Pannelli in truciolare di qualità, spess. 30 mm

schäfer[®]
Trennwandsysteme



So schön kann Trennung sein.



PRIMA DI
PRETENDERE LA FIDUCIA
DEI NOSTRI CLIENTI,
DIMOSTRIAMO IL
NOSTRO VALORE
tipico di Schäfer.

SICUREZZA CERTIFICATA DA TÜV NORD GS *tipico di Schäfer.*

Testati e certificati da TÜV NORD, questi prodotti sono conformi ai requisiti della legge sulla sicurezza dei prodotti ProdSG § 21 n. registrazione 44 329 14148802.



MADE IN GERMANY *tipico di Schäfer.*

I nostri prodotti sono realizzati nella sede aziendale di Horhausen, nella Renania-Palatinato. Solo così possiamo garantire anche i più elevati requisiti di qualità che ci poniamo per i nostri prodotti.



INNOVAZIONE E ORIENTAMENTO AL DESIGN *tipico di Schäfer.*

Con i nostri prodotti innovativi e orientati al design stupiamo non solo i nostri clienti, bensì anche gruppi di esperti nazionali e internazionali.



PREQUALIFICATE *tipico di Schäfer.*

Siamo nell'elenco delle aziende produttrici prequalificate con il numero 010.049740 a chiara indicazione che siamo qualificati per i prodotti e i servizi che offriamo.





Elegante, economico con un design collaudato.

Il modello Schäfer modello SVF30, per chi desidera avere una cabina economica, funzionale con un design ricercato. Le cabine con pannelli di truciolato rivestiti di resina melamminica e bordi chiusi con un profilo ABS garantiscono una lunga durata negli ambienti asciutti. Con questo prodotto avete tutto in uno: elegante, funzionale, economico e facile da pulire. Questi sono argomenti vincenti per questo tipo di divisori.



Caratteristiche del modello SVF30

Elementi prefabbricati composti da pannelli in truciolare di qualità, spess. 30 mm

- Superficie melamminica colorata fornibile in diversi colori standard
- Tutti i bordi e spigoli a vista chiusi con profili colorati in ABS
- Superficie a filo parete
- Ideali per ambienti asciutti

Pareti divisorie per orinatoi modello SV30

- Fissati a parete
- Pannello truciolare, spess. 30 mm superficie rivestita con resina melamminica
- Bordo perimetrale con profilo ABS in colori a scelta
- Fissaggio mediante staffe/rosette in alluminio anodizzato
- Vasta scelta di colori disponibili





Dettagli modello SVF30

Piedini:



- Piedino regolabile in acciaio inox con rosetta di copertura



- Piedino regolabile in alluminio anodizzato con rosetta di copertura

Cerniere:



- Cerniera in acciaio inox con apertura max. 180° senza chiusura automatica



- Cerniera in acciaio inox con boccole in nylon per chiusura automatica

Varianti di dotazione modello SVF30

Complementi:



Coppia maniglia
in alluminio
Schäfer AL7050



Coppia maniglia
in acciaio inox
Schäfer ES6050



Coppia maniglia
in nylon
Schäfer N8051



Pomolo in alluminio
tipo INSAFE



Maniglia SLIDESAFE
in alluminio

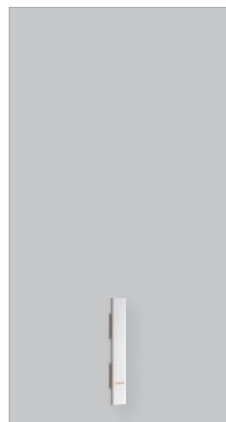

Maniglia a barra
in alluminio
55 x 500 mm
Schäfer ALGS1

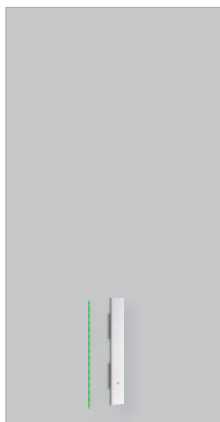

Maniglia a barra in
alluminio con striscia LED
55 x 500 mm
Schäfer ALGS1 LED



Maniglia a barra
in alluminio
55 x 1.150 mm
Schäfer ALGS2

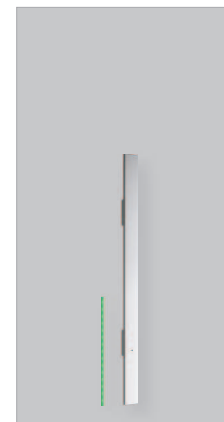

Maniglia a barra in
alluminio con striscia LED
55 x 1.150 mm
Schäfer ALGS2 LED

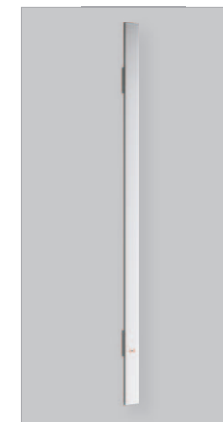

Maniglia a barra
in alluminio, adatto
all'altezza della porta
Schäfer ALGSV

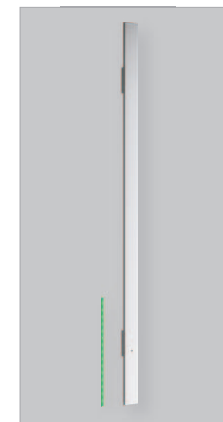

Maniglia a barra in
alluminio con striscia LED,
adatto all'altezza della porta
Schäfer ALGSV LED

[Configura ora la maniglia a barra online >](#)

[Vai alla maniglia di spinta SLIDESAFE >](#)

Respingenti e ganci:



Puffer per porte
in alluminio
Schäfer AL7015



Puffer per porte
in acciaio inox
Schäfer ES6015

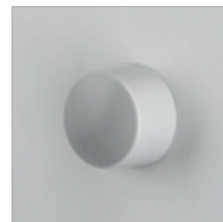

Puffer per porte
in nylon
Schäfer N8015



Appendiabiti
in alluminio
Schäfer AL7011



Appendiabiti
in acciaio inox
Schäfer ES6011



Appendiabiti
in nylon
Schäfer N8010

Cartella colori per il modello SVF30

Pannelli e porte:



1001
Bianco

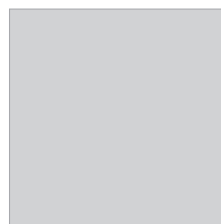

1002
Grigio argento



1004
Antracite



1005
Rosso



1006
Verde limone



1007
Blu acqua

Bordi ABS:



1001
Bianco

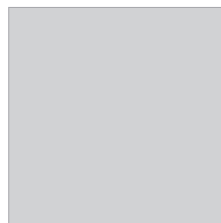

1002
Grigio argento



1004
Antracite



1005
Rosso



6001
Giallo oro



1006
Verde limone



1007
Blu acqua



6002
Blu oltremare

Profili e fissaggi:

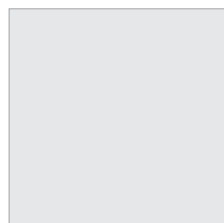

E6/EV1
Alluminio anodizzato

Per il modello SVF30S sono disponibili i colori bianco (3001), antracite (3004) e nero (3009).

I colori speciali per le decorazioni dei pannelli e i bordi ABS, nonché in tutti i colori RAL e i complementi speciali sono disponibili sulla base dei vostri desideri.

Sono possibili variazioni di colore rispetto all'originale.

Dettagli tecnici modello SVF30

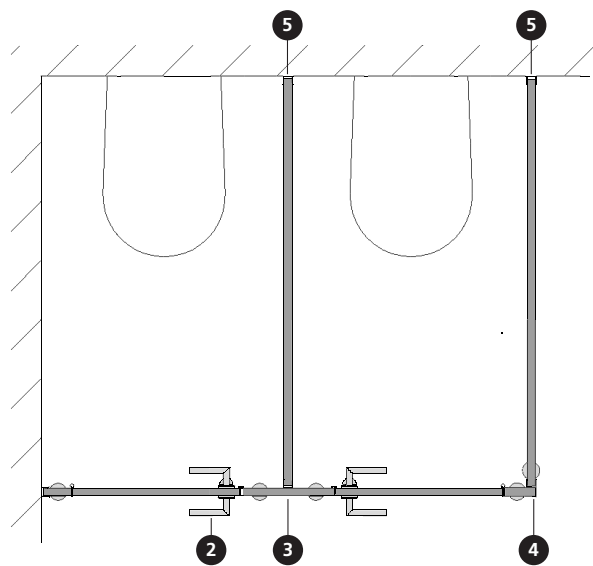

2 Vista planimetrica frontale con porta con cerniera 180°

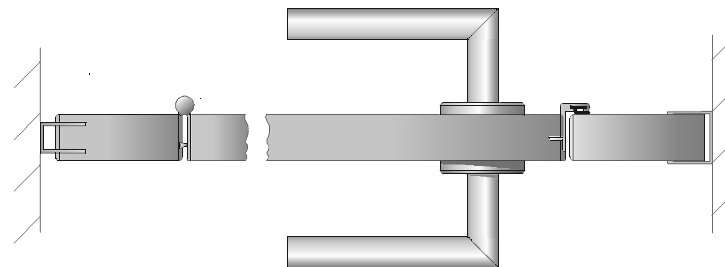

3 Fissaggio interno parete (parete divisoria - parete frontale)

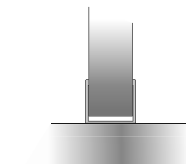

Sezione verticale

4 Raccordo angolare

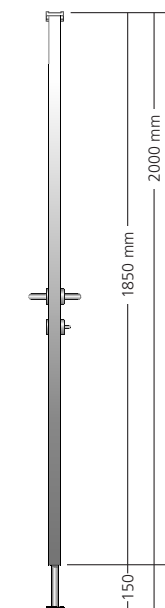

5 Fissaggio a parete con profilo a U

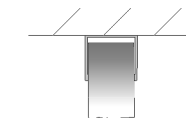

5 Fissaggio a parete con profilo interno a parete

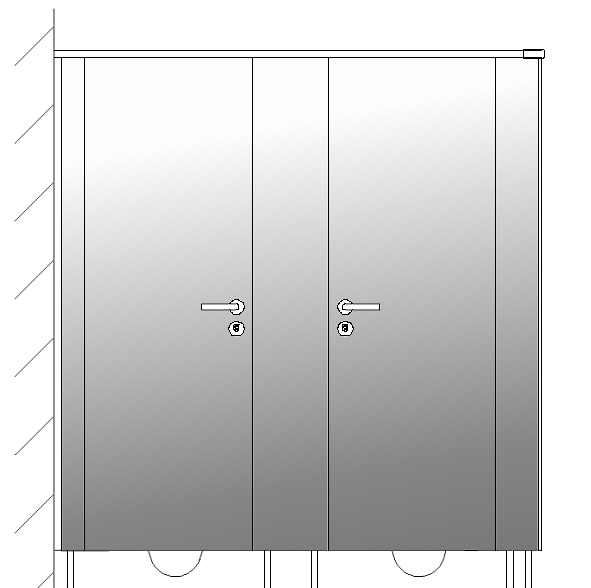
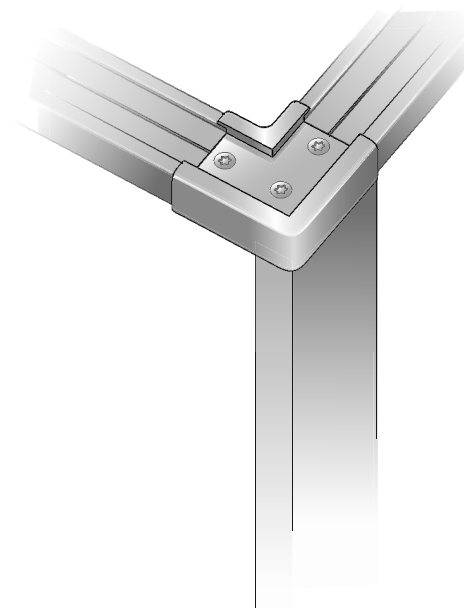
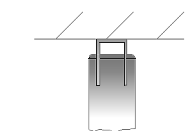

Modifiche tecniche riservate.

Schäfer Trennwandsysteme GmbH
Industriepark 37
D-56593 Horhausen
Tel.: +49 (0)2687/9151-0
info@schaefer-tws.de
www.schaefer-tws.de

Schäfer Trennwandsysteme GmbH
Ufficio Italia
Via Feldgatter 2/3
I-39011 Lana (BZ)
Tel.: +39 0473 / 864760
info@schaefer-tws.it
www.schaefer-tws.it



red dot winner 2021



GERMAN
INNO
VATION
AWARD '22
WINNER

